

型号: T200-10Q

(1) 品名: 金属网罩

Bearing Construction: oil/double ball

(2) 材质: 水抽线/304不锈钢

Material: water pumping line/304

(3) 加工定制: 是

Processing Custom: Yes

(4) 线径: 1.8*1.8mm

Line diameter: 1.8 * 1.8 mm

(5) 测拉力强度: 大于20kg

Tensile strength: more than 20kg

(6) 技术面光泽镀铜镍铬

Glossy copper-nickel-chromium plating on technical surface

(7) 未注公差为±0.5

The unspecified tolerance is ± 0.5



Dimensions Drawing(外观图)

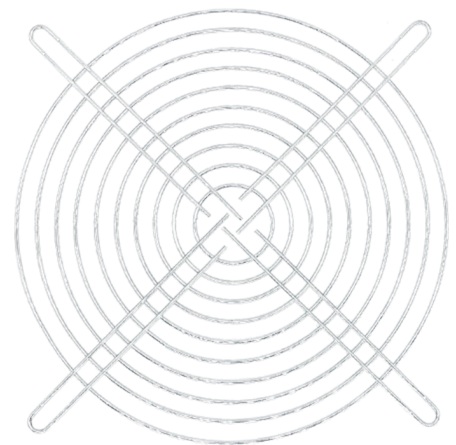
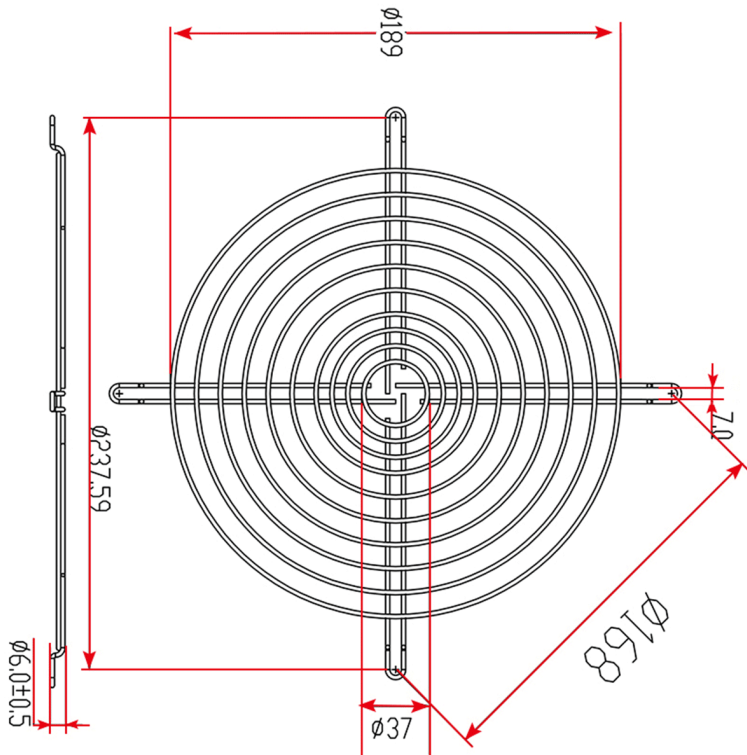

DC FAN
DC风扇

AC FAN
AC风扇

EC FAN
EC风扇

External Rotor Fan
外转子风机

Centrifugal Fan
离心风机

Constant current fan
恒流风机

Fan Shroud
风扇网罩